

Frameless Construction

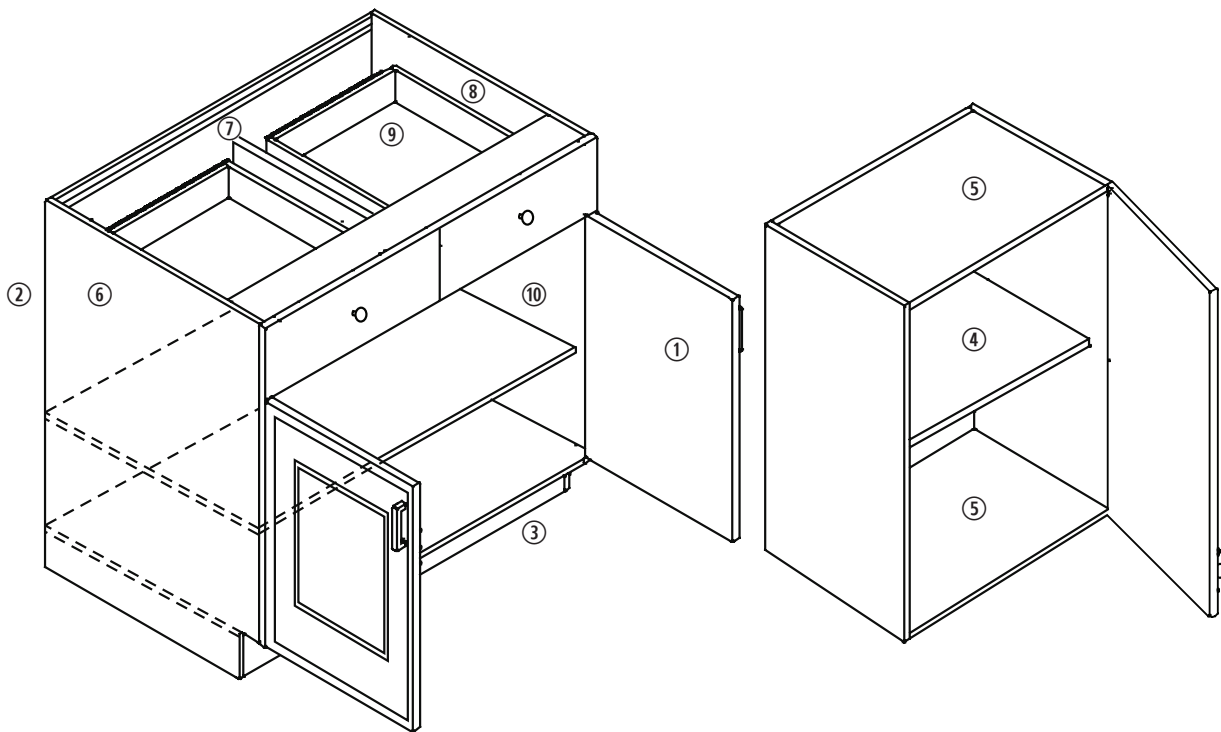

- ① Hinge – European Full Overlay
- ② Construction Type – Doweled w/Captured Back
- ③ Base Bottom – ¾" Melamine
- ④ Shelves – ¾" Melamine
- ⑤ Wall Top/Bottoms – ¾" Melamine
- ⑥ Backs – ¼" Full Back
- ⑦ Drawer Guides – Epoxy 75lb
- ⑧ Drawer Box – ⅝" White Melamine
- ⑨ Drawer Bottom – ¼" Encapsulated
- ⑩ Interiors – White Melamine

Frameless Door Styles



Ashby



Craftsman



Cypress



Ella



Mia*



Monterey



Revere



Sarah



Shaker



Sierra



Spyglass

*Frameless and Melamine finishes only

Paint Selections



Anew Gray

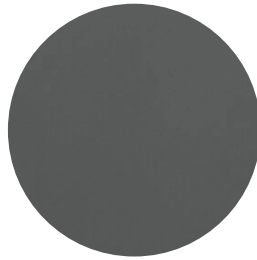

Battleship Gray

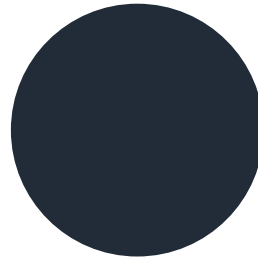

Denim

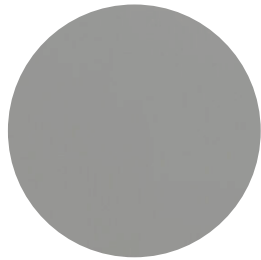

Dove Gray



Ebony

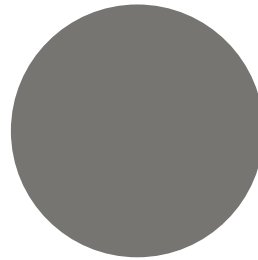

Flint

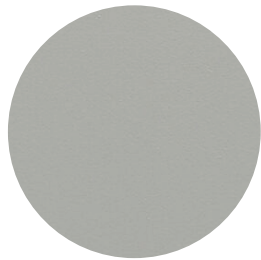

Stone

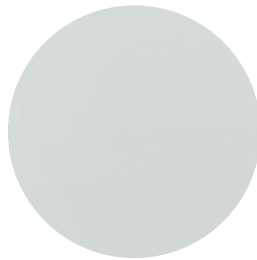

Swiss Coffee

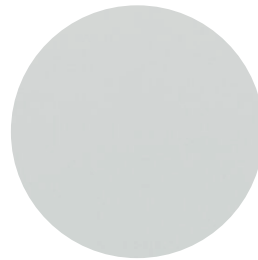

Winter White

Melamine Selections

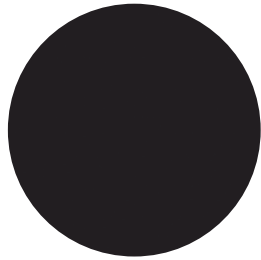

Almanor



Amador



Berryessa



Bianco



Havasú



Natoma



Manzanita

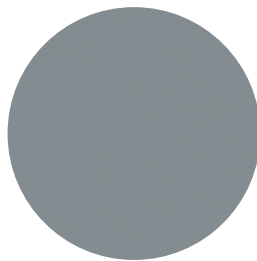

Tahoe



Tioga

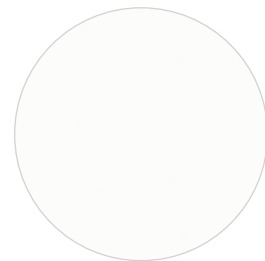

Tulloch

Melamine finishes available on the Mia door style only.

Stain Selections

Available in Beech or Maple



Avalon



Chocolate



Espresso



French Walnut



Kalua



Natural



Sedona



Sienna



Smoked Grey